



Model IS-150/IS-150T

Passive Infrared Motion Sensor

Range: 50' x 40'(15 m x 12 m)

INSTALLATION INSTRUCTIONS

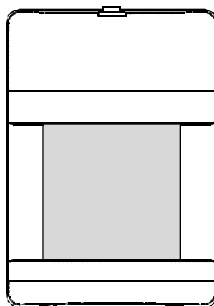

The IS-150/IS-150T passive infrared motion sensor from IntelliSense provides reliable detection coverage at an affordable price. The unit features a dense 50' x 40' pattern, including two look-down zones. Other important features include RF and white light immunity, a low 20 mA current draw and a tamper (IS-150T only).

The IS-150/IS-150T is compact, attractive, easy to install and maintain. The unit can be mounted almost anywhere **indoors**: on walls or in corners.

FEATURES

- 50' x 40' range
- Selectable detection range 50' (15m) to 32' (10m) (IS-150T only)
- Dual element PIR
- Dense detection pattern
- Wide angle lens included
- Low 20 mA current draw at 12 VDC
- 10 - 14 VDC operation
- Energized form A alarm relay
- RF and white light immunity
- Selectable PIR sensitivity
- Mounting flexibility: on walls or in corners
- Bug proof
- Tamper switch (IS-150T only)
- Remote LED Enable signal (IS-150T only)

MOUNTING LOCATION

The IS-150/IS-150T is designed for use **indoors**. Make sure the sensor has a clear line of sight to the protected area. Infrared energy cannot penetrate solid objects. If the sensor is blocked, it will not alarm.

Aim the sensor toward the interior of the room, away from windows and heating/cooling sources. The unit can be corner or wall mounted at either 4', 7'6", or 10' (see Range Chart on the next page).

MOUNTING PROCEDURE

Prepare the sensor for mounting by removing the front cover and printed circuit board (PCB). To remove the front cover of the sensor, use a screwdriver to slide into the latch release slot located at the top of the unit and then gently push up. (See Figure 1.)

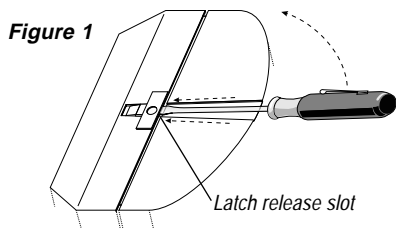

To remove the (PCB), press the latch holding the PCB in place and gently pull up on the PCB until it releases.

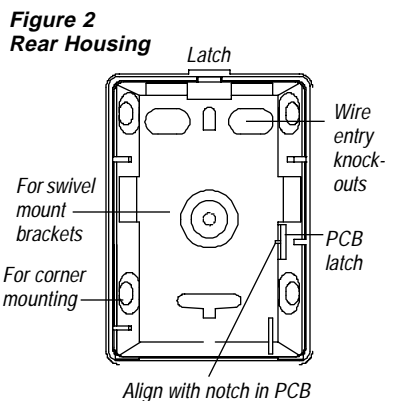

Using the rear housing as a template, use wire entry knockouts to mark holes in wall for desired mounting location. Pull several inches of wire into the housing. Drill holes and fasten rear housing to wall.

WIRING

Terminals TB1 and TB2 are located at the top side edge of the PCB. Wire the IS-150/IS-150T as shown in Figure 3 using 22 to 14 AWG wire.

Figure 3
Terminal Block

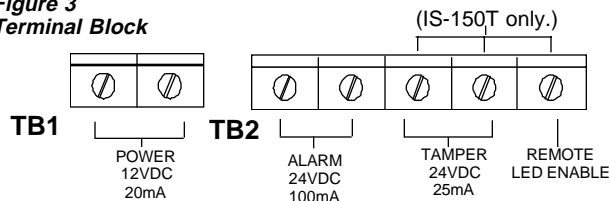

CHANGING THE FRESNEL LENS

To install the optional pet-alley lens*:

- Remove the IS-150/IS-150T's front cover. (See Figure 4.)
- Press up on the Bug Guard latch and then pull the Bug Guard out of the front cover.
- Remove the existing lens, and place the new lens in with the SMOOTH side facing outward.
- Install the lens with the small slot at the top and the large notch at the bottom.
- Install the look-down mask (optional) over the inside of the look-down window.
- Snap the Bug Guard back into place, then reassemble the housing.

*Lens Option Kit Part Number 0-000-012-01

Important: When using pet-alley lens, optimum mounting height is 4 feet and adjust PCB to +1 position.

Figure 4
Changing the Lens

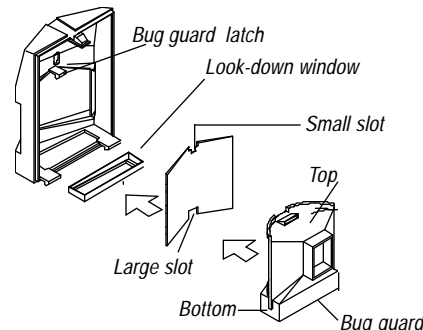

Figure 5
Printed Circuit Board

DS1 (Alarm LED) illuminates when an alarm condition is triggered.

Install jumper at W1 to enable Alarm LED (DS1). Jumper is factory installed. (IS-150T only.)

Remove jumper at W3 to decrease detection range from 50' (15m) to 32' (10m). (IS-150T only.)

Install jumper at W2 to set PIR sensitivity. Jumper is factory set to NORMAL.

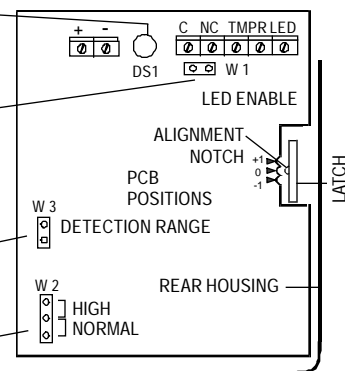

Important: Align with appropriate notch on the PCB (refer to Range Chart on the next page).

Using the chart below, configure the IS-150/IS-150T for the sensitivity best suited to your application.

SENSITIVITY	JUMPER W2 POSITION
High	Jumper top & center pins
Normal	Jumper center & bottom pins

WALK-TEST

Apply power to the unit and let it warm up for **three minutes**. Begin walk-testing when the alarm LED (DS1) goes out.

Walk across the protected area at the ranges to be covered. Two to four normal steps across the pattern should make the alarm LED light. Wait for the alarm LED to go out, then continue walk-testing. When there is no motion in the protected area, the alarm LED should be off.

Important: The IS-150/IS-150T should be tested at least **once each year** to ensure proper operation.

ALARM LED DISABLE (IS-150T only)

To disable the alarm LED (DS1) after walk-testing the sensor, remove the jumper from position **W1** on the PCB. See Figure 4.

Tip: Park the jumper on *one* of the **W1** pins (i.e. no short) to store for future use.

REMOTE LED ENABLE (IS-150T only)

This is an input signal to the sensor terminal block (labeled "LED") that allows the Alarm LED to be enabled remotely. As long as the signal is held low (grounded), the Alarm LED will illuminate when the sensor detects an alarm condition. Note that the Alarm LED is enabled by this signal, even if the LED Disable jumper (W1) is removed.

LED ENABLE	PCB JUMPER W1	ALARM LED
Not Grounded	Shorted/Installed	On
Not Grounded	Open/Not Installed	Off
Grounded	Open/Not Installed	On
Grounded	Shorted/Installed	On

SPECIFICATIONS

Range:
50' x 40' / 32' x 40'
(15 m x 12 m) / (10 m x 12 m)

Power requirements:
10 - 14 VDC, 20 mA, 12 VDC
3V peak to peak at nominal
12 VDC

Alarm relay:
Form A (normally-closed)
100 mA, 24 VDC

Tamper Switch (IS-150T only)
Closed with cover in place
25 mA, at 24 VDC

RF immunity:
30 V/m
10 MHz - 1000 MHz

White light immunity:
6,500 LUX

PIR sensitivity:
Jumper selectable
(normal & high)

Important: The IS-150/IS-150T must be connected to a UL listed power supply or UL listed control unit capable of providing a **minimum of four hours** of standby power.

PIR fields of view:
dual element, 22 long range zones
6 intermediate, 3 lower,
2 look-down

Operating temperature:
32° to 120° F (0° to 49° C)

Relative Humidity:
5% to 95% noncondensing

Dimensions:
3-1/2" H x 2-1/2" W x 1-5/8" D
(9.0 cm x 4.4 cm x 4.12 cm)

Weight:
3.0 oz (85.27g)
Packaged Product is 4.5 oz
(127.9 g)

Approvals/Listings:
CE
UL listed

PROTECTION PATTERNS

TOP VIEW - Wide Angle Lens

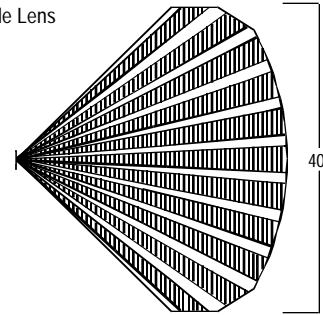

SIDE VIEW - Wide Angle Lens

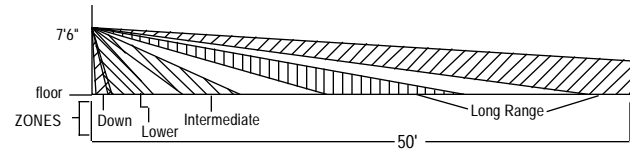

TOP VIEW - Pet-Alley Lens

The TOP VIEW Pet-Alley lens is the same as the TOP VIEW Wide Angle lens.

SIDE VIEW - Pet-Alley Lens

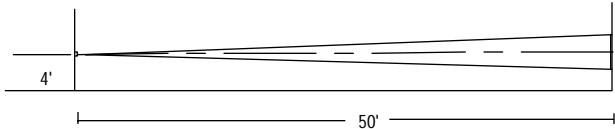

MTG HEIGHT	PCB POSITION		
	+1	0	-1
4'	50'	N/A	N/A
7'6"	N/A	50'	N/A
10'	N/A	N/A	50'

IS-150/IS-150T RANGE CHART (50'/15m)

LIMITED WARRANTY

Seller warrants its products to be in accordance with its own plans and specifications and to be free from defects in materials and workmanship under normal use and service for **18 months** from the date stamp control on the product; or for products not having an IntelliSense Systems date stamp, for **12 months** from the date of original purchase, unless the installation instructions or catalogue sets forth a shorter period, in which case the shorter period shall apply.

Seller's obligation shall be limited to repairing or replacing, at its option, free of charge for materials or labor, any part which is proved not in compliance with Seller's specifications or proves defective in materials or workmanship under normal use and service. This warranty is void if the product is altered or improperly repaired or serviced by anyone other than an authorized IntelliSense factory service center. For warranty service contact the nearest IntelliSense Service Center.

THERE ARE NO WARRANTIES, EXPRESS OR IMPLIED, OF MERCHANTABILITY, OR FITNESS FOR A PARTICULAR PURPOSE OR OTHERWISE, WHICH EXTEND BEYOND THE DESCRIPTION ON THE FACE HEREOF. In no case shall Seller be liable to anyone for any consequential or incidental damages for breach of this or any other warranty, express or implied, or upon any other basis of liability whatsoever, even if the loss or damage is caused by Seller's own negligence or fault.

Seller does not represent that its product may not be compromised or circumvented; that the product will prevent any personal injury or property loss by burglary, robbery, fire, or otherwise; or that the product will in all cases provide adequate warning or protection. Buyer understands that a properly installed and maintained alarm system may only reduce the risk of burglary, robbery, or fire without warning, but it is not insurance or guarantee that such will not occur or that there will be no personal injury or property loss as a result. CONSEQUENTLY, SELLER SHALL HAVE NO LIABILITY FOR ANY PERSONAL INJURY, PROPERTY DAMAGE, OR OTHER LOSS BASED ON A CLAIM THAT THE PRODUCT FAILED TO GIVE WARNING. However, if Seller be held liable, whether directly or indirectly, for any loss or damage arising under this Limited Warranty or otherwise, regardless of cause or origin, Seller's maximum liability shall not in any case exceed the purchase price of the product, which shall be fixed as liquidated damages and not as a penalty, and shall be the complete and exclusive remedy against Seller.

This warranty replaces all previous warranties and is the only warranty made by IntelliSense on this product. No increase or alteration, written or verbal, of the obligation of this warranty is authorized.



Copyright 1995, C&K Systems, Inc.
C&K is a registered trademark of C&K Components, Inc.
IntelliSense is a registered trademark of C&K Systems, Inc.
All rights reserved.

5-051-432-00 Rev A